

**Rasonic**  
樂信牌

**RRC-YC06B**

迷你微電腦電飯煲

Mini Microcomputer Rice Cooker



僅供家庭使用  
For household use only

# 使用說明書 OPERATION MANUAL

- 在使用本產品前，請仔細閱讀本說明書，閱讀後小心收藏，以備日後查閱。  
Please read the operation manual carefully before using. Keep it in a safe place for future reference.
- 本說明書中的圖示可能與實物有不同的地方，僅供參考。  
The images in the operation manual may not match with the real object and are for reference only.



非常感謝您選購樂信牌迷你微電腦電飯煲，使用前請先詳細閱讀本說明書，並保存以備日後參考。



## 目錄

1. 安全注意事項
2. 保養、清潔及儲存
3. 產品規格
4. 產品結構
5. 使用方法
6. 其他功能
7. 故障排除
8. 特別聲明
9. 售後服務



## 1. 安全注意事項







使用本產品時，必須遵守下列安全措施：

下圖表示由於錯誤操作而引起不同程度的危險等級。









	<b>警告：</b> 此標誌表示可能造成傷亡。
	<b>注意：</b> 此標誌表示可能造成傷害或財物損失。

以下不同標誌區分各種必須遵守的指示。

	此標誌表示禁止。
	此標誌表示必須遵守。

 <b>警告</b>			
	切勿讓小孩單獨使用、清潔及維修保養電飯煲或玩耍器具。請將電飯煲及其電線放於小孩不能觸及的地方。		請單獨使用額定電流 10 安培或以上及帶接地線插座。
	切勿擅自改裝電飯煲或使用非生產商提供的零件進行修理，否則可造成危險及維修保養無效。		手濕時切勿接觸、插入或拔除插頭，否則可構成觸電的危險。
	切勿讓電飯煲在無人看管下或沒有內鍋時運作。		切勿使用有殘缺或鬆動的插座。使用前，確保機身插座及電源插頭已充分擦乾。



 警告			
	<p>為避免燙傷，使用時或剛使用後，切勿將臉或手靠近上蓋或蒸氣口；切勿觸摸剛使用後的發熱板及內鍋，因仍有餘熱。</p>		<p>此電飯煲只可作家庭或類似環境使用，如商店內部、辦事處和其他工作環境的員工廚房區域；旅館、汽車旅館和其他住宿類型的環境。</p>
	<p>切勿把機身、電源線或插頭浸入水中；或被水濺濕，並避免溢在連接器上，以免造成觸電及火災。</p>		<p>使用時，切勿用任何物件覆蓋電飯煲表面或遮擋蒸氣口，以免造成電飯煲故障、變形或變色。</p>
	<p>切勿使用變形的內鍋，以免因與發熱板接觸不良而引致故障。</p>		<p>使用前，確保電源線兩端的插頭已分別插穩在電飯煲及電源插座上。</p>
	<p>此電飯煲可供年齡在8歲或以上的兒童及體質、感覺或智力有障礙人士或缺乏經驗和相關知識的人士使用，但他們必須接受負責安全人士的監督或指導如何安全地使用電飯煲和理解所涉及的危險。</p>		<p>經常檢查電飯煲、內鍋、電源線及插頭，如有損壞，為避免危險，請立即停止使用，並聯絡信興電器服務中心有限公司安排檢查及維修。</p>



注意

	<p>切勿使用其他器皿來取代原裝內鍋。</p>		<p>使用時，切勿打開上蓋、移動或搖晃電飯煲，以免造成危險。</p>
	<p>使用前，確定內鍋外部及發熱板表面清潔乾爽，否則可能引致故障。</p>		<p>切勿使用內鍋直接淘米，以免損害內鍋表面的塗層，影響烹調效果。</p>
	<p>切勿用火加熱內鍋，否則會損壞內鍋。</p>		<p>使用後要清潔，切勿用內鍋烹調酸性或鹼性的食物，以免損壞內鍋塗層。</p>
	<p>煮食份量不可超過內鍋內最高水位線，否則可能有水從蒸氣口噴出。</p>		<p>在插入或拔除插頭時，應用手握穩插頭，不要抓住電源線。</p>
	<p>切勿在電源線纏結的情況下使用或將電源線懸掛在桌子、櫥櫃的邊緣或讓它接觸灼熱的表面，否則會損壞電源線。</p>		<p>切勿在以下環境使用電飯煲：</p> <ul style="list-style-type: none"> <li>- 潮濕或近水的環境</li> <li>- 靠近熱源如電焗爐、電磁爐及火源</li> <li>- 不平穩的表面上</li> <li>- 易燃物料或不耐熱物品附近(如枱布、窗簾及毛巾等)</li> </ul>
	<p>使用後，請從電源插座拔出插頭及待電飯煲冷卻後才移動、清潔或檢查電飯煲。</p>		<p>不可在電源線上放重物、夾住、改裝、用力拉扯或扭曲電源線。</p>

## 2. 保養、清潔及儲存

1. 清潔前，必須拔除電源插頭，並待電飯煲完全冷卻。
2. 清洗內鍋和內蓋時，請使用海綿等軟性物料及清潔劑，用水沖洗後再抹乾及裝回原位。
3. 如有食物黏在內鍋，清洗前可先用水浸泡一會。
4. 如發熱板、機身或上蓋有污穢，可用濕布抹淨後再抹乾。清潔時切勿將產品浸入水中。
5. 為免損壞內鍋塗層，盛飯時請使用原裝飯勺，切勿使用金屬餐具或在內鍋中切割食物。
6. 切勿使用有毒或含腐蝕性的清潔劑或粗硬的潔具(如鋼絲刷)進行清潔。
7. 長時間使用後，內鍋表面可能會變色，此乃正常現象並不會影響食物安全及內鍋的使用。
8. 儲存時，請將電飯煲放入紙箱並放置在乾爽的環境中。
9. 儲存時，切勿將電源線纏繞在電飯煲四周或壓住電源線，以免造成電源線損壞。

## 3. 產品規格

型號	RRC-YC06B
額定電壓	220-240伏特~ 50/60赫茲
額定功率	400-480瓦
容量(最多4杯米)	0.64升(約)
淨重(約)	2.4公斤
產品尺寸(約)(闊 x 深 x 高)	262 x 210 x 193毫米

## 4. 產品結構

### 控制面板



### 產品結構

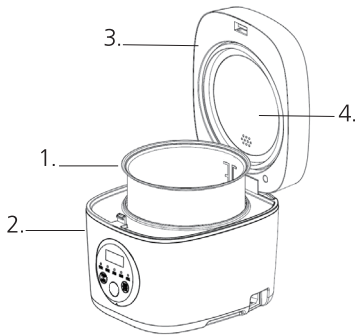

1. 內鍋
2. 機身
3. 上蓋
4. 內蓋
5. 開蓋按鈕
6. 蒸氣口
7. 控制面板
8. 電源插座
9. 量杯
10. 電源線
11. 飯勺
12. 蒸架
13. 湯勺

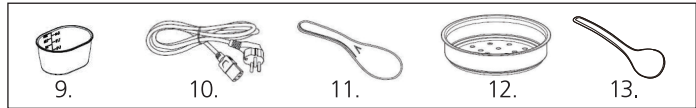

## 5. 使用方法

### 5.1 各功能的烹調容量及時間：

烹調功能	烹調最少分量	烹調最多分量	預設煮食時間	保溫時間	可預約時間範圍
快煮	1杯米／水位 RICE刻度1	4杯米／水位 RICE刻度4	27-34分鐘	00:00 – 24:00	01:00 – 24:00
煮飯	1杯米／水位 RICE刻度1	4杯米／水位 RICE刻度4	38-42分鐘		01:00 – 24:00
煲湯	食材及水不可 低於水位CONGEE 刻度1/2	食材及水不可 高於水位CONGEE 刻度3/4	2小時		02:00 – 24:00
煲粥	1/2杯米／水位 CONGEE刻度1/2	食材及水不可 高於水位CONGEE 刻度3/4	1小時30分鐘		01:30 – 24:00

- ※ 烹調功能的烹調時間不能調整。
- ※ 煮飯的實際時間會根據不同米量、水量、電壓、室溫、水溫及米質而變化。
- ※ 米飯的軟硬會因不同米量、水量及米質而影響，並有可能產生鍋巴。

### 5.2 快煮／煮飯功能

1. 使用原裝量杯量米，1杯米平口盛滿，供一至二人食用量。
2. 洗米及加水
  - (1) 將清洗乾淨的米倒入內鍋。請勿在內鍋直接洗米，避免磨擦內鍋塗層。
  - (2) 加入適量的水。如煮1杯米的米飯份量，請加水入內鍋至“RICE”水位線刻度1的位置。
    - ※ 用戶可按個人口感的喜好適量地調節水量。
    - ※ 切勿用熱水煮飯，否則會影響溫控器的運作及米飯的口感。
    - ※ 請確保鍋內的米要均勻分佈。
3. 將內鍋放入電飯煲中。
  - (1) 放入內鍋前，請確保內鍋外側及底部已抹乾和清潔；如發熱板表面有異物，應立刻清除，否則煮食時會有雜聲及可能造成故障。
  - (2) 將內鍋平放於電飯煲內及確保內鍋與發熱板充分接觸。
4. 關上上蓋，直至聽到“咔嚓”一聲。
5. 連接電源，電飯煲會發出一聲響聲，顯示屏會顯示並閃亮“-:-:-”，表示處於待機狀態。
6. 按【食譜／取消】鍵選擇功能，直至所選功能燈閃亮。按【開始】鍵啟動功能，所選功能指示燈會轉為長亮，顯示屏會顯示“[ ]”。

7. 完成後，電飯煲會發出五聲響聲。所選功能指示燈會熄滅，保溫功能指示燈亮起，顯示窗會顯示“0:00”，並顯示已保溫的時間。  
※ 建議讓米飯在電飯煲內保溫10-15分鐘才食用，米飯會更鬆軟可口。
8. 使用後，按【食譜／取消】鍵回到待機狀態，並拔除電源插頭。

### 5.3 煲粥功能

1. 使用原裝量杯量米，1/2杯米，約一至二人食用量。
2. 洗米及加水
  - (1) 將清洗乾淨的米倒入內鍋。請勿在內鍋直接洗米，避免磨擦內鍋塗層。
  - (2) 加入適量的水。如煮1/2杯米的粥份量，加水入內鍋至水位線CONGEE刻度1/2的位置。  
※ 用戶可按個人口感的喜好適量地調節水量。  
※ 切勿用熱水烹調，否則會影響溫控器的運作及米的口感。  
※ 請確保鍋內的米要均勻分佈。
3. 將內鍋放入電飯煲中。
  - (1) 放入內鍋前，請確保內鍋外側及底部已抹乾和清潔；如發熱板表面有異物，應立刻清除，否則煮食時會有雜聲及可能造成故障。
  - (2) 將內鍋平放於電飯煲內及確保內鍋與發熱板充分接觸。
4. 關上上蓋，直至聽到“咔嚓”一聲。
5. 連接電源，電飯煲會發出一聲響聲，顯示屏會顯示“-:-:-”，表示處於待機狀態。
6. 按【食譜／取消】鍵選擇功能，直至所選功能燈閃亮。按【開始】鍵啟動功能，所選功能指示燈會轉為長亮，顯示屏會開始倒數計時。
7. 完成後，電飯煲會發出五聲響聲。所選功能指示燈會熄滅，保溫功能指示燈會亮起，顯示屏會顯示“0:00”，並顯示已保溫的時間。
8. 使用後，按【食譜／取消】鍵回到待機狀態，並拔除電源插頭。

### 5.4 煲湯功能

1. 洗食材及加水
  - (1) 將清洗乾淨的食材倒入內鍋。請勿在內鍋直接洗食材，避免磨擦內鍋塗層。
  - (2) 加入適量的水。如煲最少份量的湯，加水入內鍋至水位線CONGEE刻度1/2的位置。  
※ 用戶可按個人口感的喜好適量地調節水量。  
※ 切勿用熱水烹調，否則會影響溫控器的運作及食材的口感。  
※ 請確保鍋內的食材要均勻分佈。

- 將內鍋放入電飯煲中。
  - 放入內鍋前，請確保內鍋外側及底部已抹乾和清潔；如發熱板表面有異物，應立刻清除，否則煮食時會有雜聲及可能造成故障。
  - 將內鍋平放於電飯煲內及確保內鍋與發熱板充分接觸。
- 關上上蓋，直至聽到“咔嚓”一聲。
- 連接電源，電飯煲會發出一聲響聲，顯示屏會顯示“- - - -”，表示處於待機狀態。
- 按【食譜/取消】鍵選擇功能，直至所選功能燈閃亮。按【開始】鍵啟動功能，所選功能指示燈會轉為長亮，顯示屏會開始倒數計時。
- 完成後，電飯煲會發出五聲響聲。所選功能指示燈會熄滅，保溫功能指示燈會亮起，顯示屏會顯示“0:00”開始倒數保溫時間。
- 使用後，按【食譜／取消】鍵回到待機狀態，並拔除電源插頭。

## 6. 其他功能

### 6.1 保溫功能

注意！除保溫功能外，各功能完成後均會進入保溫狀態。

- 在待機狀態下，按【食譜／取消】鍵可選擇保溫功能，按下【開始】鍵啟動保溫功能，顯示屏會顯示“24:00”，並且開始倒數保溫時間。
- 保溫時，請將米飯翻鬆及關上上蓋，以免米飯變乾及結塊。
- 保溫時間最長為24小時，之後電飯煲會自動轉為待機狀態。
- 切勿將米飯或食物保溫過長時間，否則會產生鍋巴、異味及食物變質。
- 在保溫狀態下，按【食譜／取消】鍵，可取消保溫功能。

### 6.2 預約功能(預約完成運作時間)

- 接通電源，按【食譜／取消】鍵選擇功能。
- 按【預約】鍵開始設定預約，顯示窗會顯示預設預約時間，預約指示燈閃亮。若需調整預約時間，每按【預約】鍵一次，時間值會遞增30分鐘(超過10小時，時間值每次遞增1小時)，具體功能的運作時間及份量請參考**章節5.1各功能的烹調容量及時間**。
- 設定後，按【開始】鍵啟動預約功能，預約指示燈轉為常亮，顯示屏會倒數預約完成時間。  
※ 建議預約時間不要超過12小時，以免食物變質及產生異味。

### 6.3 斷電記憶

如使用時出現供電不正常、插頭被不小心拔掉或需移動產品等情況，如10分鐘內重新接上電源，產品會恢復原來的工作狀態。

## 7. 故障排除

故障現象	原因	解決方法
1. 指示燈不亮。	電源尚未連接穩妥。	檢查插頭、插座及電源線是否完好，以及是否完全插入插座。
	電源插頭或內部零件損壞。	請送回信興電器服務中心有限公司檢查及維修。
2. 指示燈亮起，發熱板不熱。	內部零件或發熱板零件損壞。	請送回信興電器服務中心有限公司進行檢查及維修。
3. 飯煮不熟或米飯焦黑。	米量及水量的比例不正確。	調整米量及水量的比例。
	發熱板變形或內部零件損壞。	請送回信興電器服務中心有限公司進行檢查及維修。
	內鍋未有水平放置於發熱板上。	將內鍋輕輕轉動直至與發熱板充分接觸。
4. 煮粥時溢出。	米量或水量過多。	適量減少米或水。
5. 顯示窗出現E1、E2、E3或E4。	傳感器出現故障。	請送回信興電器服務中心有限公司檢查及維修。
6. 沒有在預約的時間完成煮飯功能。	沒有按【開始】鍵啟動設定。	按【開始】鍵啟動預約功能。
7. 煮飯時，有奇怪的聲音。	輕微的“咔嚓”聲，是自動調整火力的聲音，屬正常現象。	電飯煲是安全的，可繼續使用。
	內鍋與發熱板之間有異物影響接觸。	清除異物。

如以上方法未能使電飯煲恢復正常操作，請聯絡信興電器服務中心有限公司進行檢查及維修。

## 8. 特別聲明

1. 本資料上所有內容經過核對，如有任何印刷及內容上的誤解，本公司將保留解釋權。
2. 本產品若有技術改進，會編進新版說明書中，恕不另行通知；產品外觀、顏色如有改動，則以製造商生產資料為準。
3. 如本資料之中英文版本有差異時，應以中文版為準。
4. 使用說明書的電子副本可以通過電子郵件發送致客戶，如有需要，可致電信興電工工程有限公司：2861 2767。

## 9. 售後服務

1. 由購買收據日期起之一一年保修期內，經信興電器服務中心有限公司之服務人員證實產品故障屬於正常使用之情況下發生者，本公司將提供免費維修或更換零件服務。經更換之任何損壞零件，將歸屬本公司所有。保修範圍不包括修理或更換產品之損耗性零件(例如：內鍋)等。
2. 用戶必須於維修時出示購買收據／換購收據及蓋有銷售點／換購中心印章的產品保修記錄卡。如有任何疑問，請致電信興電器服務中心有限公司熱線：2406 5666查詢。



Thank you for choosing Rasonic mini microcomputer rice cooker. Please read the operation manual carefully before use and keep it for your future reference.



## Table of Contents

1. Important Safeguards
2. Maintenance, Cleaning and Storage
3. Product Specifications
4. Product Descriptions
5. Operation Instructions
6. Other Functions
7. Troubleshooting
8. Special Avowal
9. After Sales Service



## 1. Important Safeguards





When using the appliance, please follow the below safety precautions:

The following chart indicates the degree of damage caused by wrong operation.

	<b>WARNING:</b> Indicates that may cause death or serious injury.
	<b>CAUTION:</b> Indicates hazards that may cause human injuries or property damages.

The following symbols can distinguish the instruction types that need to be strictly followed.

	These symbols mean prohibition.
	These symbols mean requirement that must be followed.

 <b>WARNING</b>			
	Never allow children to operate, clean, perform maintenance on the appliance alone or play as toy. Please put the appliance and its power cord in a place not reachable by children.		Please use an individual socket with rated current 10A plug or above and earth wire.
	Do not attempt to modify the appliance by yourself or repair with any unauthorized parts, otherwise it will cause hazards and warranty will become invalid.		Do not touch, plug in or remove the plug with wet hands, it can cause electric shock.



## WARNING

	Never leave the appliance unattended when in use or operate without inner pot.		Do not use deficient or loosen socket. Make sure the appliance inlet and plug are dry before use.
	To avoid burn, do not get your face or hands close to the lid or steam vent during use or right after use; never touch the heating plate and inner pot which are subject to residual heat right after use.		The appliance is intended to be used in household or similar applications such as staff kitchen in shops, offices and other working environments; by clients in hotels, motels and other residential type environments.
	Never immerse the main body, power cord or plug in water or let them wet and avoid spillage on the connector, it can cause electric shock and fire.		When in use, do not cover the appliance surface or steam vent with any objects to avoid appliance malfunction, deformation or discoloration.
	Do not use deformed inner pot to avoid malfunction due to poor contact with heating plate.		Before use, please make sure both ends of the power cord are plugged in tightly on the appliance and the power socket.



**WARNING**



The appliance can be used by children aged from 8 years and above and persons with reduced physical, sensory or mental capabilities, or lack of experience and knowledge, if they have given supervision or instruction concerning use of the appliance in a safe way and understand the hazards involved.



Always check the condition of the appliance, inner pot, power cord and plug. If any of the parts is damaged, stop using the appliance immediately to avoid hazard and contact Shun Hing Electric Service Centre Limited for checking and repairing.



**CAUTION**



Do not use other container to substitute the original inner pot.



Do not open the lid, move or shake the appliance when in use, it can cause danger.



Make sure the inner pot outer surface and heating plate are clean and dry before use, otherwise it may cause malfunction.



Do not wash rice directly inside the inner pot to avoid scratching the coating and affect the cooking performance.



Do not heat the inner pot with fire, it will cause damage.



Clean after use. Do not cook acidic or alkaline food in the inner pot to avoid damage on the inner pot coating.



## CAUTION

	<p>The cooking amount cannot exceed the maximum water level of the inner pot to prevent water spilling from the steam vent.</p>		<p>Grasp the plug itself when plug in or unplug the appliance, do not grasp the power cord.</p>
	<p>Do not operate the appliance when the power cord is tangled or hang the power cord over the edge of table, counter-top or let it touch any hot surface, it may cause power cord damage.</p>		<p>Do not operate the appliance in the following places:</p> <ul style="list-style-type: none"><li>- Humid environment or near water</li><li>- Near heat sources such as electric oven, induction cooker and fire</li><li>- Unstable surface</li><li>- Near inflammable or non-resistant to heat objects (e.g. table cloth, curtain and towel etc.)</li></ul>
	<p>After use, please remove the plug and let the appliance cool down before moving, cleaning or checking.</p>		<p>Do not place heavy objects on the power cord. Never clip, modify, stretch or twist the power cord.</p>

## 2. Maintenance, Cleaning and Storage

1. Before cleaning, the plug must be removed and let the rice cooker cool down completely.
2. When clean the inner pot and lid, please use soft materials such as sponge and detergent. Rinse with water and rub them dry. Put them in place after cleaned.
3. If food residual sticks on the inner pot, please soak the inner pot with water for a while before cleaning.
4. If dirt is attached on the heating plate, main body or lid, use a damp cloth to clean and wipe them dry. Do not immerse the appliance in water for cleaning.
5. To avoid damage on the inner pot coating, please use original rice scoop when serving rice, never use metal utensils or cut food in the inner pot.
6. Never use poisonous or corrosive detergent or harsh tools (e.g. metal-wired brush) for cleaning.
7. The color of inner pot may change after using a period of time, however it does not affect the food safety and function of the inner pot.
8. When store, put the appliance in a box and store in a dry place.
9. When store, never wrap the power cord around the appliance or clip the power cord to prevent power cord damage.

## 3. Product Specifications

Model	RRC-YC06B
Rated Voltage	220-240V~ 50/60 Hz
Rated Power	400-480W
Capacity (Max. 4 cup of rice)	0.64L (approx.)
Net Weight (approx.)	2.4 kg
Product Dimension (W x D x H) (approx.)	262 x 210 x 193 mm

## 4. Product Descriptions

### Control Panel



### Product Structures

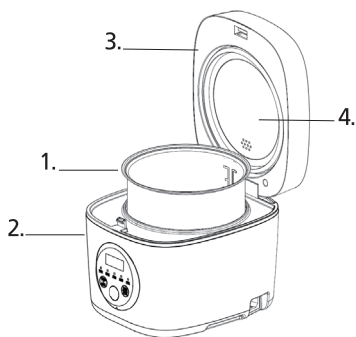

1. Inner pot
2. Main body
3. Lid
4. Inner lid
5. Lid open button
6. Steam vent
7. Control panel
8. Power Connector
9. Measuring cup
10. Power cord
11. Rice scoop
12. Steam rack
13. Soup scoop

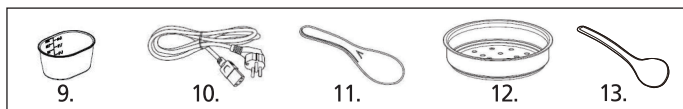

## 5. Operation Instructions

### 5.1 The cooking amount and time of different functions:

Function	Min. amount of cooking	Max. amount of cooking	Default cooking time	Keep warm time	Preset time arrange
Quick	1cup rice/1-cup RICE water level	4 cups rice/4-cup RICE water level	27-34 mins	00:00 – 24:00	01:00 – 24:00
Rice	1cup rice/1-cup RICE water level	4 cups rice/4-cup RICE water level	38-42 mins		01:00 – 24:00
Soup	Ingredients and water must not lower than 1/2 CONGEE water level	Ingredients and water must not higher than CONGEE water level 3/4	2 hrs		02:00 – 24:00
Porridge	1/2 cup rice/ 1/2-cup CONGEE water level	Ingredients and water must not higher than CONGEE water level 3/4	1 hr 30 mins		01:30 – 24:00

- ※ The cooking time for cooking functions are not adjustable.
- ※ The actual rice cooking time is varied with different rice quantity, water amount, voltage, room temperature, water temperature and rice quality.
- ※ The rice texture is affected by different rice quality, water amount and rice quality which are even possible to form crust.

### 5.2 Quick/Rice:

1. Use the original measuring cup to measure rice, one full cups of rice are approximately for one to two persons.
2. Wash rice and add water.
  - (1) Put the rinsed rice in the inner pot. Do not wash rice directly inside the inner pot to avoid scratching the coating.
  - (2) Add suitable amount of water. To cook 1 cup of rice, please add water to the inner pot until marking 1 on the "RICE" indication line.
    - ※ The water amount can be adjusted according to personal preference on the rice texture.
    - ※ Do not cook with hot water, it will affect the thermostat operation and the rice texture.
    - ※ Make sure the rice is evenly distributed in the inner pot.
3. Put the inner pot inside the rice cooker.
  - (1) Before putting in the inner pot, make sure the outer surface and bottom of the inner pot are wiped dry and clean. If foreign substance is attached on the heating plate, please remove it immediately. Otherwise, it will cause noise during cooking and possibly malfunction.
  - (2) Put the inner pot into the rice cooker and ensure it is directly in contact with the heating plate.



4. Close the lid until a "click" sound is heard.
5. Connect the power, a beep sound will be heard, display will show and flash "--:--". It means it is in the stand-by status.
6. Press [ Menu/Cancel ] key to select the function until the white flash to the selected function. Press [ Start ] key to start cooking, the indication light will stay on, display will show [ \_ \_ \_ ].
7. After cook, 5 beep sounds will be heard. The indication light of selected function will be off, the keep warm function light will on and the display will show the "0:00".
  - ※ It is recommended to keep the rice in keep-warm status for 10-15 minutes before served, the rice would become soft and taste better.
8. After use, press [ Menu/Cancel ] key to return to stand-by status, then unplug the rice cooker from the power socket.

### 5.3 Porridge

1. Use the original measuring cup to measure rice, 1/2 cups of rice are approximately for one to two persons.
2. Wash rice and add water.
  - (1) Put the rinsed rice in the inner pot. Do not wash rice directly inside the inner pot to avoid scratching the coating.
  - (2) Add suitable amount of water. To cook porridge with 1/2 cup of rice, please add water to the inner pot until marking 1/2 "CONGEE" water level.
    - ※ The water amount can be adjusted according to personal preference on the rice texture.
    - ※ Do not cook with hot water, it will affect the thermostat operation and the rice texture.
    - ※ Make sure the rice is evenly distributed in the inner pot.
3. Put the inner pot inside the rice cooker.
  - (1) Before putting in the inner pot, make sure the outer surface and bottom of the inner pot are wiped dry and clean. If foreign substance is attached on the heating plate, please remove it immediately. Otherwise, it will cause noise during cooking and possibly malfunction.
  - (2) Put the inner pot into the rice cooker and ensure it is directly in contact with the heating plate.
4. Close the lid until a "click" sound is heard.
5. Connect the power, a beep sound will be heard, display will show and flash"--:--". It means it is in the stand-by status.
6. Press [ Menu/Cancel ] key to select the function until the white flash to the selected function. Press [ Start ] key to start cooking, the indication light will stay on and display will start to countdown the cooking time.
7. After cook, 5 beep sounds will be heard. The indication light of selected function will be off, the keep warm function light will on and the display will show the "0:00".
  - ※ It is recommended to keep the rice in keep-warm status for 10-15 minutes before served, the rice would become soft and taste better.
8. After use, press [ Menu/Cancel ] key to return to stand-by status, then unplug the rice cooker from the power socket.

## 5.4 Soup

1. Wash ingredients and add water.
  - (1) Put the rinsed ingredients in the inner pot. Do not wash ingredients directly inside the inner pot to avoid scratching the coating.
  - (2) Add suitable amount of water. To cook minimum with 1/2 cup of soup, please add water to the inner pot until marking 1/2 "CONGEE" water level.
    - ※ The water amount can be adjusted according to personal preference on the rice texture.
    - ※ Do not cook with hot water, it will affect the thermostat operation and the rice texture.
    - ※ Make sure the ingredients is evenly distributed in the inner pot.
2. Put the inner pot inside the rice cooker.
  - (1) Before putting in the inner pot, make sure the outer surface and bottom of the inner pot are wiped dry and clean. If foreign substance is attached on the heating plate, please remove it immediately. Otherwise, it will cause noise during cooking and possibly malfunction.
  - (2) Put the inner pot into the rice cooker and ensure it is directly in contact with the heating plate.
3. Close the lid until a "click" sound is heard.
4. Connect the power, a beep sound will be heard, display will show and flash "--:--". It means it is in the stand-by status.
5. Press [ Menu/Cancel ] key to select the function until the white flash to the selected function. Press [ Start ] key to start cooking, the indication light will stay on and display will start to countdown the cooking time.
6. After cook, 5 beep sounds will be heard. The indication light of selected function will be off, the keep warm function light will on and the display will show the "0:00"
  - ※ It is recommended to keep the rice in keep-warm status for 10-15 minutes before served, the rice would become soft and taste better.
7. After use, press [ Menu/Cancel ] key to return to stand-by status, then unplug the rice cooker from the power socket.

## 6. Other Functions

### 6.1 Keep warm function

**CAUTION!** When each cooking function is completed, the rice cooker will return to keep warm status.

1. In the standby status, press [ Menu/Cancel ] key to select the keep warm function, the indicator light on and display will show "24:00", press [ Start ] key to activate the keep warm function.
2. During keep warm, please stir the rice occasionally and close the lid. It is to avoid the rice becomes dry and clamp.
3. The maximum keep warm time is 24 hours, the rice cooker will then turn to stand-by status automatically.
4. Do not let the rice or food to keep warm for too long, otherwise it may have crust, bad smell and deterioration.
5. Press [ Menu/Cancel ] key under keep-warm status to cancel the keep warm function.

## 6.2 Preset function (The time finish the operation)

1. Connect the power, press [ Menu/Cancel ] key to select the function.
2. Press [ Preset ] key to set the preset time. Display will show default preset time, preset indicator light will flash. If need to adjust the preset time, each press of [ Preset ] key, the time digits will increase by 30 minutes respectively (over 10 hours the time digits will increase by 1 hour respectively), more details about the operation time please refer to Chapter 5.1 **The cooking amount and time of different functions.**
3. After setting, press [ Start ] key to start the preset function, the preset indicator light will on and display will start to count down the finish time of the operation.
  - ※ Do not preset the time over 12 hours to avoid food deterioration and bad smell.

## 6.3 Power cut-off memory

If there is an abnormal power supply, the plug is removed accidentally or to move the appliance during operation, after the power supply is connected in 10 minutes, the appliance will resume the original operation.

## 7. Troubleshooting

Problem	Cause	Solution
1. Indication light does not work.	The power source is not connected properly.	Check whether the plug, socket and the power cord is in good condition and make sure the plug is firmly inserted into the socket.
	The plug or the internal parts are damaged.	Please send to Shun Hing Electric Service Centre Ltd. for checking and repairing.
2. Indication light is on but the heating plate is not heated.	The internal parts or the heating plate is damaged.	Please send to Shun Hing Electric Service Centre Ltd. for checking and repairing.
3. Rice is under-cooked or burnt.	The proportion of rice to water is incorrect.	Adjust the amount of water to rice with the correct proportion.
	Heating plate is deformed or the internal parts are damaged.	Please send to Shun Hing Electric Service Centre Ltd. for checking and repairing.
	The inner pot sits improperly on the heating plate.	Slightly turn the inner pot clockwise and anti-clockwise until it fully contacts with the heating plate.
4. The porridge is overflowed.	Rice or water is too much.	Reduce proper amount of water and rice.
5. Display screen show E1、E2、E3 or E4.	The sensor is damaged.	Please send to Shun Hing Electric Service Centre Ltd. for checking or repairing.

6. The appliance fails to complete the cooking process according to the preset setting.	Forget to press [ Start ] key to confirm the preset setting.	Press [ Start ] key to confirm the preset setting.
7. Noise during cooking.	The slightly “click” sound produced is normal as the appliance auto-adjust the heating power.	The appliance is safe to use.
	There are foreign object obstructing the contact of the inner pot and the heating plate.	Remove the foreign object.

If the above solutions cannot fix the problem, please contact Shun Hing Electric Service Centre Ltd. to checking and repairing.

## 8. Special Avowal

1. The content in the operation manual has been checked. Our company reserves the hermeneutic power to any printing errors or misunderstanding on the content.
2. If there are technical improvements on the appliance, the operation manual will be updated in new version without prior notice. The product appearance and specification are subject to the manufacturer information.
3. In case there is any inconsistency or conflict between the English versions and Chinese versions of the terms, the Chinese versions shall prevail.
4. E-copy of user manual can be sent by e-mail on request, please call Shun Hing Electric Works & Engineering Co., Ltd. at 2861 2767.

## 9. After Sales Service

1. For any defect, in the judgement of technician from Shun Hing Electric Service Center Limited, caused under normal use, our company is responsible for repairing or replacing parts of the said electrical appliance free of charge within one year guarantee period commencing from the date of purchase. Any defect part which has been replaced shall become our property. Guarantee service does not cover the repair or replacement of consumable parts (e.g. inner pot) etc.
2. User must present the official invoice/redemption voucher and the product warranty card with the chop from sales point/redemption center for maintenance. For enquiries, please call Shun Hing Electric Service Center Limited hotline at 2406 5666.

# 備忘錄

---

# 備忘錄

---





SHUN HING GROUP  
信興集團  
SINCE 1953

**Rasonic 樂信牌**

## 信興電工工程有限公司

**SHUN HING ELECTRIC WORKS AND ENGINEERING CO., LTD.**

辦公室：香港九龍尖沙咀東部麼地道67號半島中心9樓

電話：2861 2767

圖文傳真：2865 6706

網址：<http://www.rasonic.com>

電郵：[shew@shunhinggroup.com](mailto:shew@shunhinggroup.com)

Office: 9/F, Peninsula Centre, 67 Mody Road, Tsimshatsui East, Kowloon, Hong Kong

Tel: 2861 2767

Fax: 2865 6706

Website: <http://www.rasonic.com>

E-mail: [shew@shunhinggroup.com](mailto:shew@shunhinggroup.com)

保養及維修 Maintenance and Repair Service:

**信興電器服務中心有限公司**

**SHUN HING ELECTRIC SERVICE CENTRE LTD.**

香港新界葵涌勝耀街2號信興中心11樓

電話：2406 5666

圖文傳真：2408 0316

網址：<http://www.shesc.com/zh>

11/F, Shun Hing Centre, 2 Shing Yiu Street, Kwai Chung, N.T. HK

Tel: 2406 5666

Fax: 2408 0316

Website: <http://www.shesc.com/zh>

客戶服務中心：

香港新界葵涌勝耀街2號信興中心1樓

九龍尖沙咀東部麼地道67號半島中心B座9樓

香港天后琉璃街7號柏景中心22樓

澳門慕拉士大馬路193-199號南嶺工業大廈5樓I座

Customer Service Centre

1/F, Shun Hing Centre, 2 Shing Yiu Street, Kwai Chung, N.T.

9/F., Block B, Peninsula Centre, 67 Mody Road, Tsim Sha Tsui East, Kowloon

22/F, Parkview Centre, 7 Lau Li Street, Tin Hau, Hong Kong

Avenida de Venceslau de Morais, No. 193-199, 5 andar - I, Edf. Industrial Nam Leng, Macau

有關最新之香港及澳門客戶服務中心資料，請參閱信興服務中心網址：<http://www.shesc.com/zh>

For the latest information of Hong Kong and Macau service center, please visit <http://www.shesc.com/en>